

Article number: 01010901
 Description: Retaining ring A 85 DIN 471
 Stainless 411
 Note: Fitted with ZGA pilers

Measures

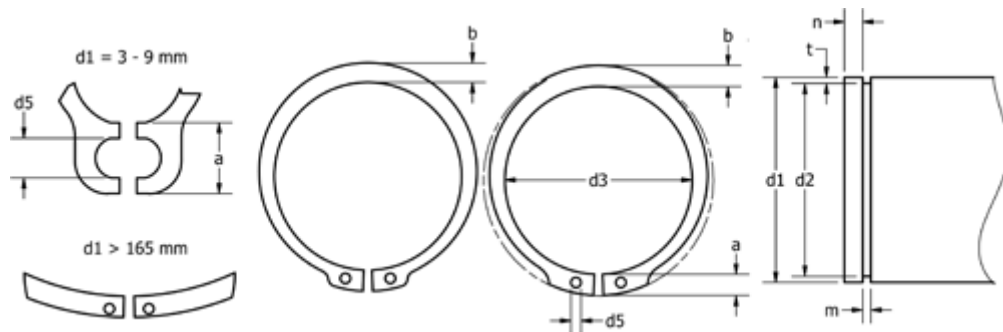

a max	= 8.7	FN kN	= 76.2	s	= 3.00
AN mm ²	= 457.0	FRg kN	= 33.40	t	= 1.75
b	= 7.8	FR kN	= 215.00	tol	= -0.35
d1	= 85	g	= 3.0	tol	= -0.08
d2	= 81.5	K kN-mm	= 405.00	tol	= +0,46-1,10
d3	= 79.5	m min	= 3.15	Tong	= ZGA-4
d5 min	= 3.0	n abl x 1000	= 6.0	Weight kg/1000	= 36.400
Description	= A85	Nominal drive	= 5.3		